

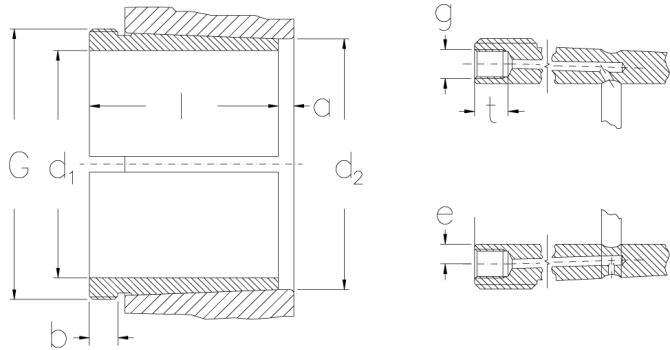

AH 2236

Withdrawal sleeves



AOH(X) & AOH(X) .. G
Kegel 1:12
(Kegel 1:30 bei H240, H241)

Technical data

d1 (mm)	170
d2 (mm)	180
l (mm)	105
a (mm)	5
G	M 200x3
b (mm)	17
g	-
e (mm)	-
t (mm)	-
Weight (kg)	3.73

GTIN/EAN



Related products

KM 40
Locknuts with metric threads

MB 34
Locking washers with metric dimensions

KM 34
Locknuts with metric threads