

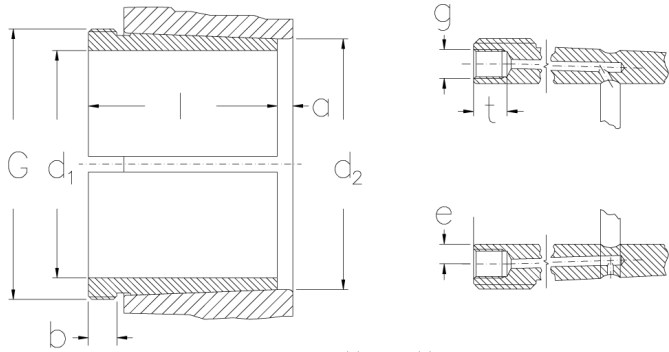

AH 2334

Withdrawal sleeves



AOH(X) & AOH(X) .. G
Kegel 1:12
(Kegel 1:30 bei H240, H241)

Technical data

d1 (mm)	160
d2 (mm)	170
l (mm)	146
a (mm)	6
G	M 190x3
b (mm)	24
g	-
e (mm)	-
t (mm)	-
Weight (kg)	5.25

GTIN/EAN



Related products

KM 38
Locknuts with metric threads

MB 32
Locking washers with metric dimensions

KM 32
Locknuts with metric threads