

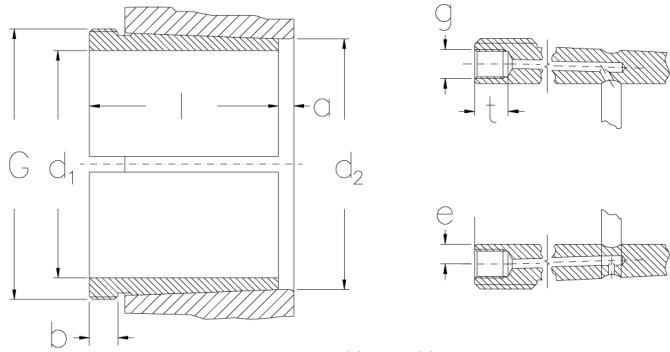

AHX 2324

Withdrawal sleeves



AOH(X) & AOH(X) .. G
Kegel 1:12
(Kegel 1:30 bei H240, H241)

Technical data

d1 (mm)	115
d2 (mm)	120
l (mm)	105
a (mm)	4
G	M 135x2
b (mm)	17
g	-
e (mm)	-
t (mm)	-
Weight (kg)	1.6

GTIN/EAN



Related products

KM 27
Locknuts with metric threads

MB 23
Locking washers with metric dimensions

KM 23
Locknuts with metric threads