

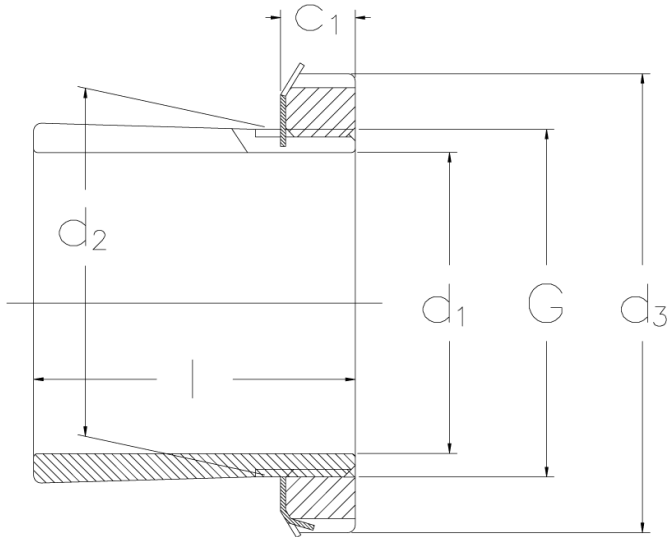

H 322-4

Adapter sleeves for inch shafts



Technical data

d1 (Inch)	4
d2 (mm)	110
l (mm)	77
d3 (mm)	145
G	M 110x2
c1 (mm)	21
Weight (kg)	1.9

GTIN/EAN



Related products

KM 22
Locknuts with metric threads

MB 22
Locking washers with metric dimensions