

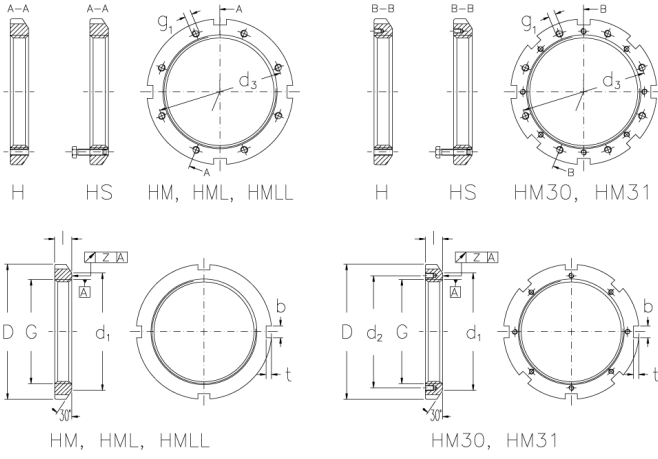

# HM 106 TH

Locknuts with trapezoidal threads



## Technical data

G	Tr 530x6
l (mm)	60
D (mm)	640
d1 (mm)	590
d2 (mm)	-
b (mm)	40
t (mm)	23
z (mm)	0.15
g1	M24
d3 (mm)	562
Weight (kg)	42.8