

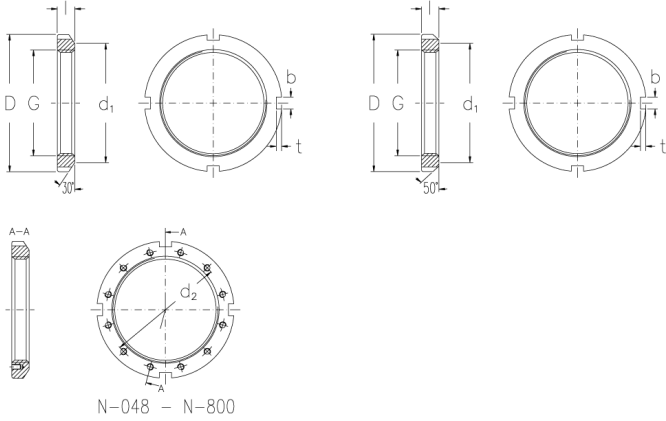

N-076

Locknuts with inch dimensions



Technical data

G (Inch)	14.957
Threads per inch	5
l (Inch)	1.916
D (Inch)	17.755
d1 (Inch)	16.625
b (Inch)	1.23
t (Inch)	0.604
d2 (Inch)	16.485
Weight (kg)	14.6
Screw	1/2 - 13-7/8

GTIN/EAN

