

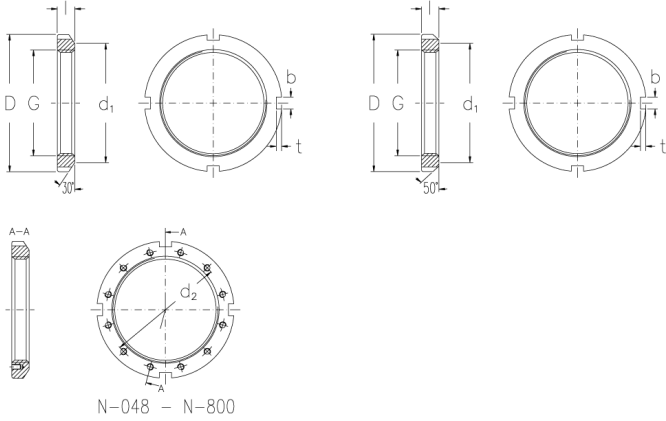

N-068

Locknuts with inch dimensions



Technical data

G (Inch)	13.339
Threads per inch	5
l (Inch)	1.791
D (Inch)	15.755
d1 (Inch)	14.813
b (Inch)	0.98
t (Inch)	0.51
d2 (Inch)	14.735
Weight (kg)	10.7
Screw	3/8 - 16-3/4

GTIN/EAN

