

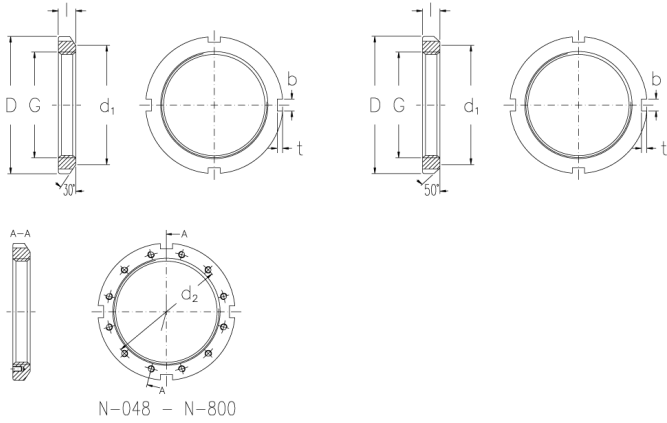

N-044

Locknuts with inch dimensions



Technical data

G (Inch)	8.628
Threads per inch	8
l (Inch)	1.26
D (Inch)	10.255
d1 (Inch)	9.531
b (Inch)	0.86
t (Inch)	0.385
d2 (Inch)	-
Weight (kg)	3.2

GTIN/EAN



Related products

W-044
Locking washers with inch dimensions