

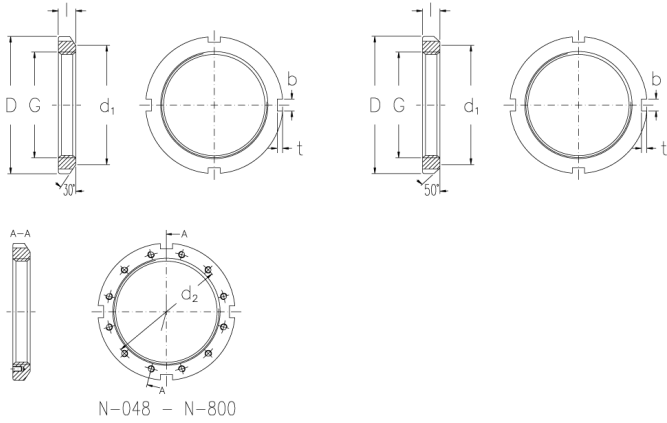

N-44

Locknuts with inch dimensions



Technical data

G (Inch)	8.628
Threads per inch	8
l (Inch)	1.26
D (Inch)	11.005
d1 (Inch)	9.843
b (Inch)	0.98
t (Inch)	0.51
d2 (Inch)	-
Weight (kg)	4.7

GTIN/EAN



Related products

W-44
Locking washers with inch dimensions