

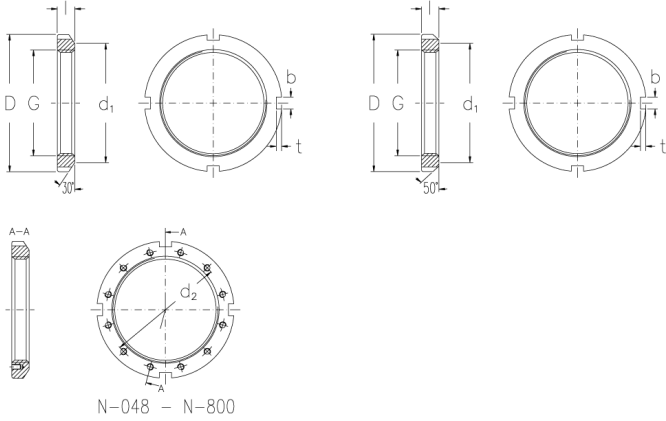

AN-32

Locknuts with inch dimensions



Technical data

G (Inch)	6.284
Threads per inch	8
l (Inch)	1.041
D (Inch)	8.068
d1 (Inch)	7.438
b (Inch)	0.61
t (Inch)	0.291
d2 (Inch)	-
Weight (kg)	2.4

GTIN/EAN



Related products

W-32
Locking washers with inch dimensions