

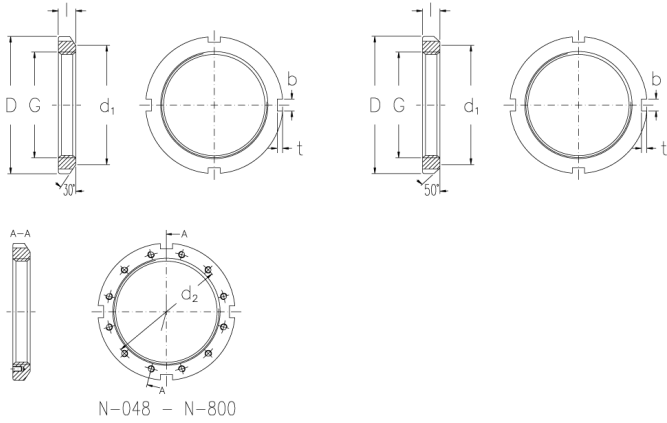

AN-15

Locknuts with inch dimensions



Technical data

G (Inch)	2.933
Threads per inch	12
l (Inch)	0.604
D (Inch)	3.88
d1 (Inch)	3.563
b (Inch)	0.36
t (Inch)	0.135
d2 (Inch)	-
Weight (kg)	0.32

GTIN/EAN



Related products

W-15
Locking washers with inch dimensions