

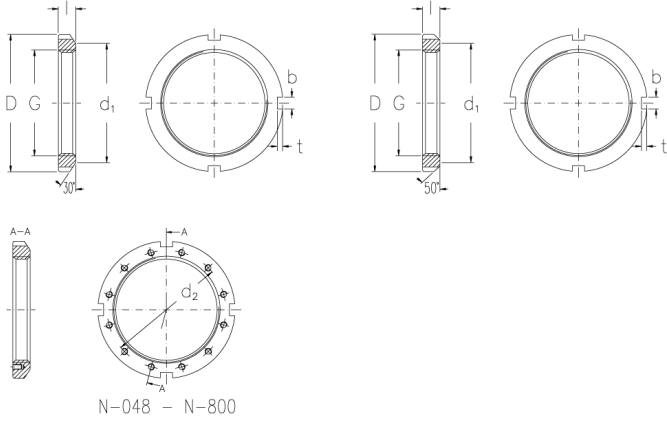

N-11

Locknuts with inch dimensions



Technical data

G (Inch)	2.157
Threads per inch	18
l (Inch)	0.51
D (Inch)	2.974
d1 (Inch)	2.656
b (Inch)	0.24
t (Inch)	0.135
d2 (Inch)	-
Weight (kg)	0.17

GTIN/EAN



Related products

W-11
Locking washers with inch dimensions