

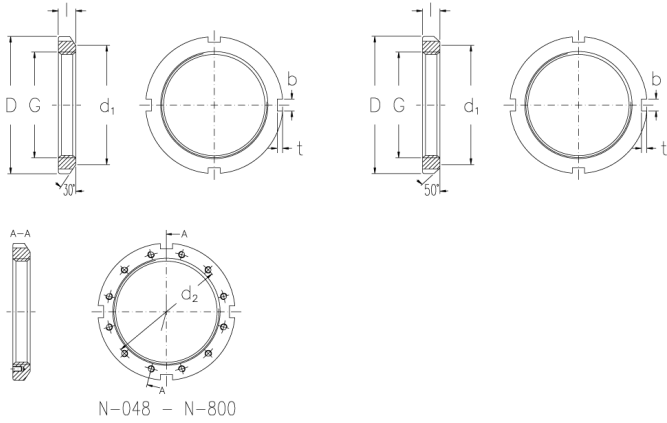

# N-06

Locknuts with inch dimensions



## Technical data

G (Inch)	1.173
Threads per inch	18
l (Inch)	0.416
D (Inch)	1.755
d1 (Inch)	1.5
b (Inch)	0.178
t (Inch)	0.104
d2 (Inch)	-
Weight (kg)	0.06

GTIN/EAN



## Related products

W-06  
Locking washers with inch dimensions