

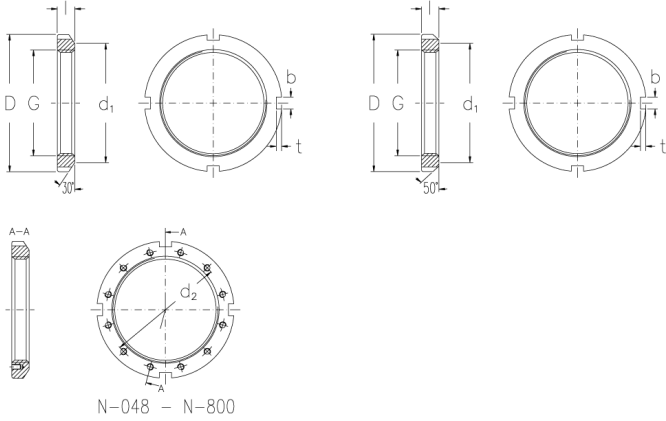

N-02

Locknuts with inch dimensions



Technical data

G (Inch)	0.586
Threads per inch	32
l (Inch)	0.323
D (Inch)	1.005
d1 (Inch)	0.813
b (Inch)	0.12
t (Inch)	0.104
d2 (Inch)	-
Weight (kg)	0.02

GTIN/EAN



Related products

W-02
Locking washers with inch dimensions