

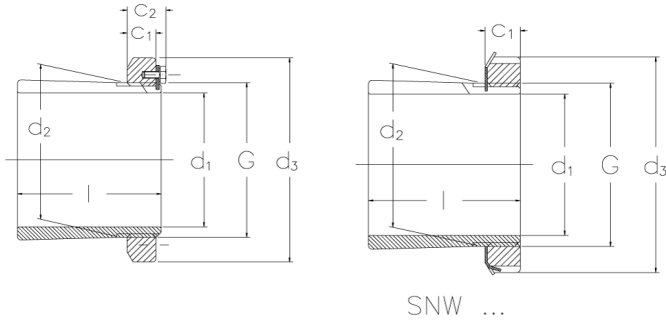

SNP 3152-9 1/2

Adapter sleeves with inch dimensions



Technical data

d1 (Inch)	9 1/2
d2 (mm)	260
l (Inch)	7.593
d3 (Inch)	12 3/16
G (Inch)	10.192
c1 (Inch)	1.416
c2 (Inch)	1.76
Threads per inch	6
Weight (kg)	20

Related products

N-052
Locknuts with inch dimensions