

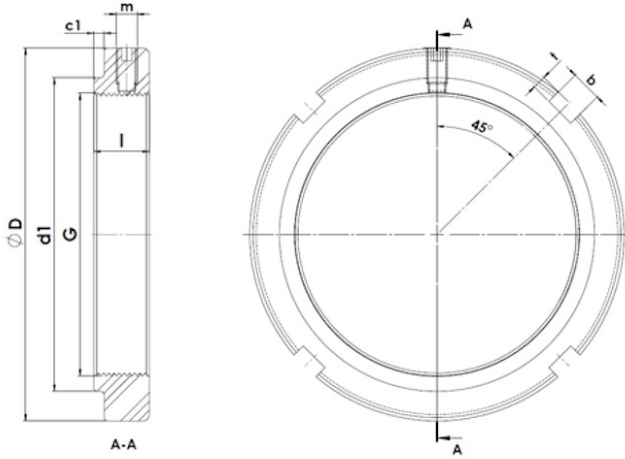

KMS1-40

Lock nut with integrated clamping element



Technical data

G	M200x3
l (mm)	34
D (mm)	250
d1 (mm)	217
c1 (mm)	12
m	M10
b (mm)	18
t (mm)	8
Weight (kg)	3.72