

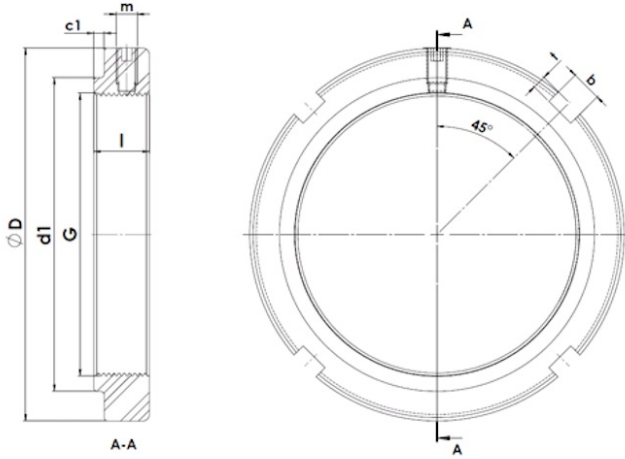

KMS1-28

Lock nut with integrated clamping element



Technical data

G	M140x2
l (mm)	28
D (mm)	180
d1 (mm)	152
c1 (mm)	7
m	M10
b (mm)	14
t (mm)	6
Weight (kg)	1.85