

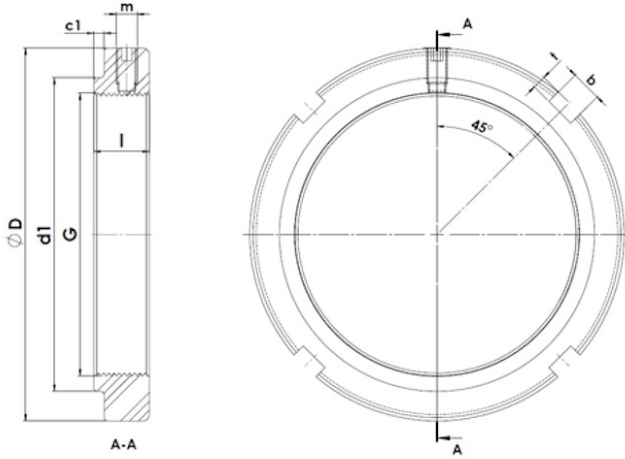

KMS1-18

Lock nut with integrated clamping element



Technical data

G	M90x2
l (mm)	19
D (mm)	120
d1 (mm)	102
c1 (mm)	4
m	M8
b (mm)	10
t (mm)	4
Weight (kg)	0.66