

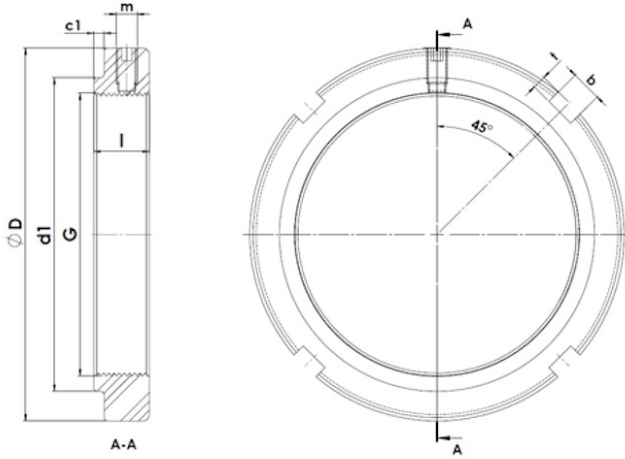

KMS1-13

Lock nut with integrated clamping element



Technical data

G	M65x2
l (mm)	15
D (mm)	85
d1 (mm)	76
c1 (mm)	3
m	M6
b (mm)	7
t (mm)	3
Weight (kg)	0.26