

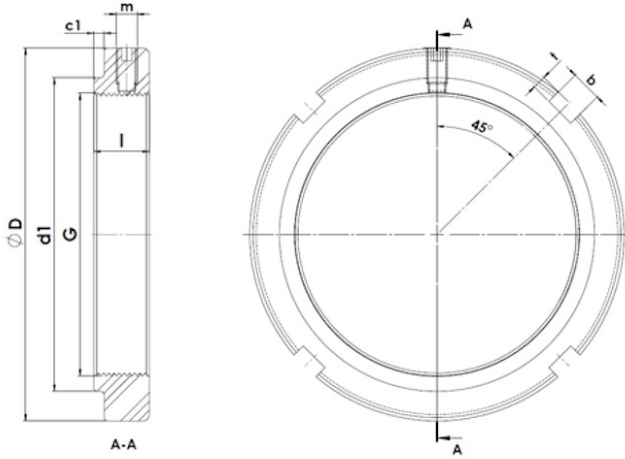

KMS1-12

Lock nut with integrated clamping element



Technical data

G	M60x2
l (mm)	14
D (mm)	80
d1 (mm)	69
c1 (mm)	3
m	M6
b (mm)	7
t (mm)	3
Weight (kg)	0.22