

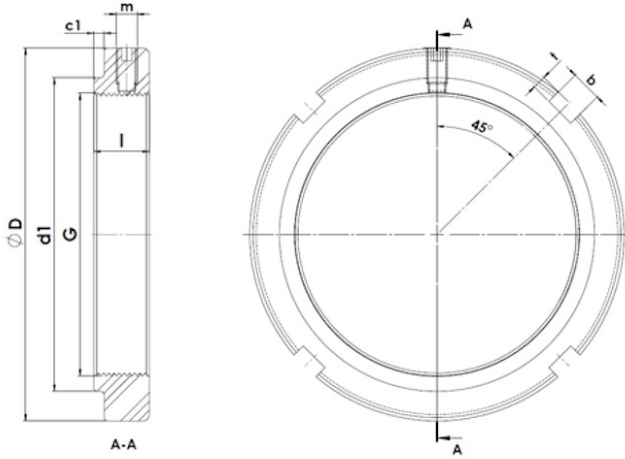

KMS1-04

Lock nut with integrated clamping element



Technical data

G	M20x1
l (mm)	9.5
D (mm)	32
d1 (mm)	26
c1 (mm)	1
m	M5
b (mm)	4
t (mm)	2
Weight (kg)	0.03