

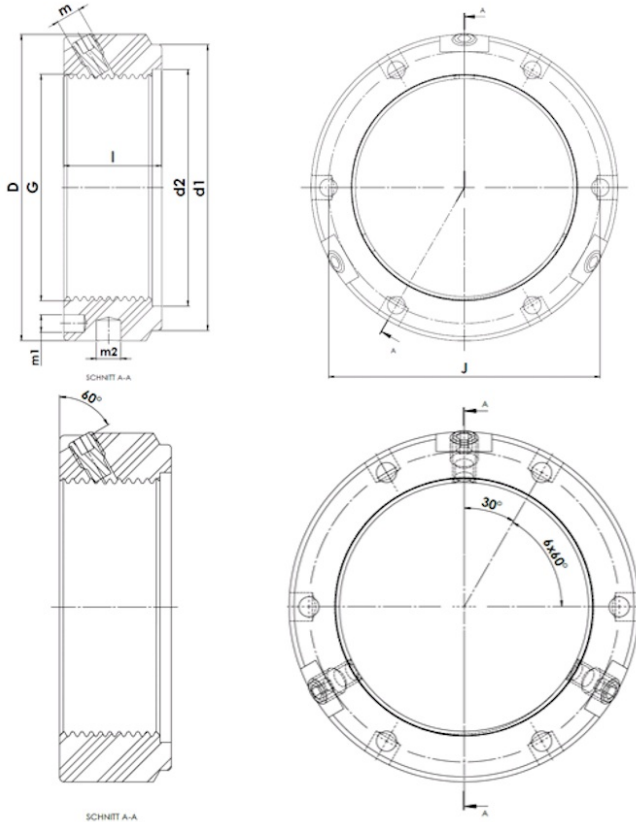

KMTA 40

KMTA - Precision clamp nut, heavy duty, with three radial clamping pins



Technical data

G	M200x3
l (mm)	32
D (mm)	245
d1 (mm)	237
d2 (mm)	202
J (mm)	229
m	M10
m1 (mm)	8
m2 (mm)	10
Weight (kg)	3.85

GTIN/EAN

