

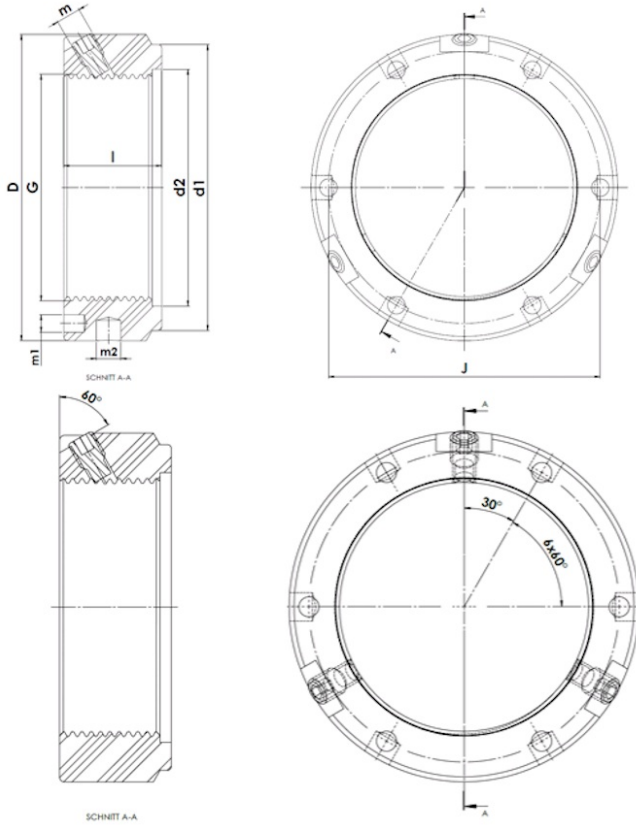

KMTA 38

KMTA - Precision clamp nut, heavy duty, with three radial clamping pins



Technical data

G	M190x3
l (mm)	32
D (mm)	240
d1 (mm)	225
d2 (mm)	192
J (mm)	224
m	M10
m1 (mm)	8
m2 (mm)	10
Weight (kg)	4.1

GTIN/EAN

