

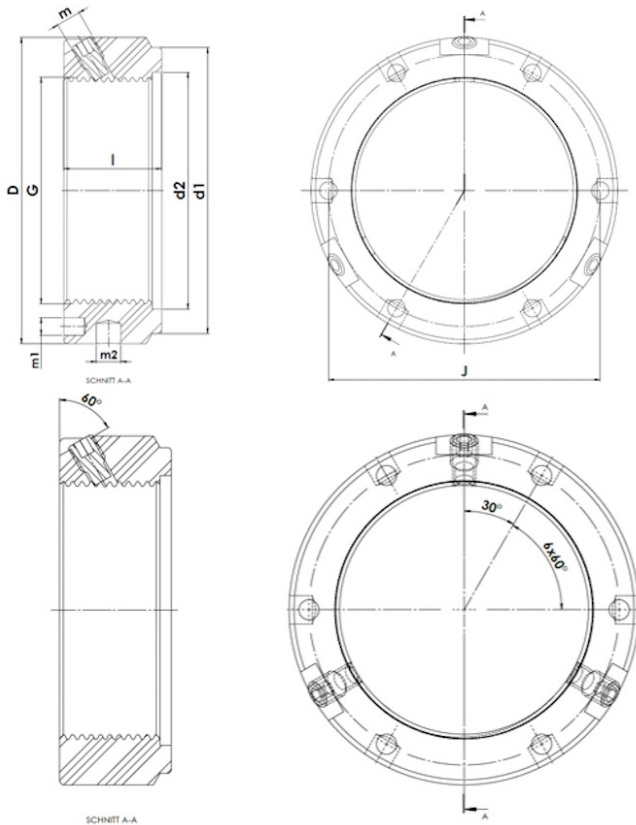

KMTA 34

KMTA - Precision clamp nut, heavy duty, with three radial clamping pins



Technical data

G	M170x3
l (mm)	32
D (mm)	215
d1 (mm)	205
d2 (mm)	172
J (mm)	195
m	M10
m1 (mm)	8
m2 (mm)	10
Weight (kg)	3.3

GTIN/EAN

