

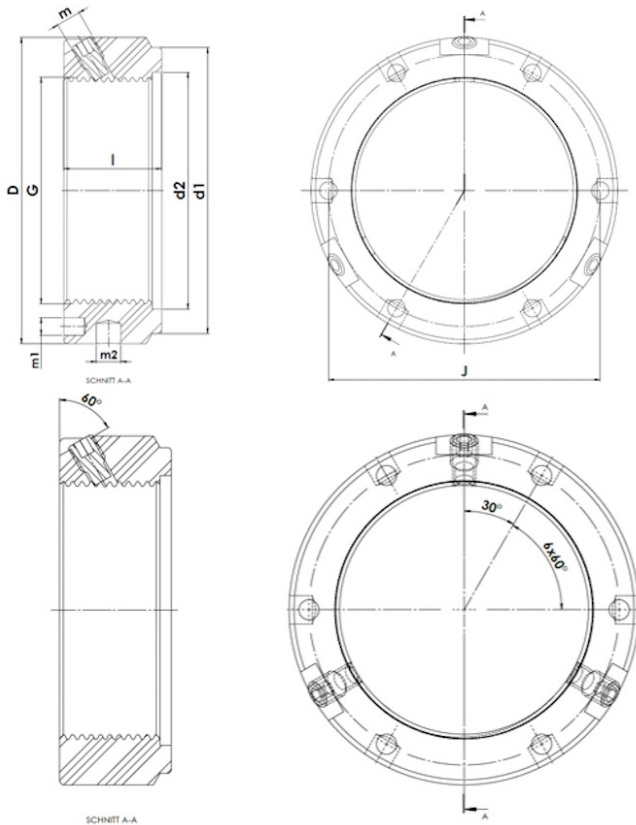

KMTA 30

KMTA - Precision clamp nut, heavy duty, with three radial clamping pins



Technical data

G	M150x3
l (mm)	32
D (mm)	190
d1 (mm)	180
d2 (mm)	152
J (mm)	175
m	M10
m1 (mm)	6
m2 (mm)	10
Weight (kg)	2.6

GTIN/EAN

