

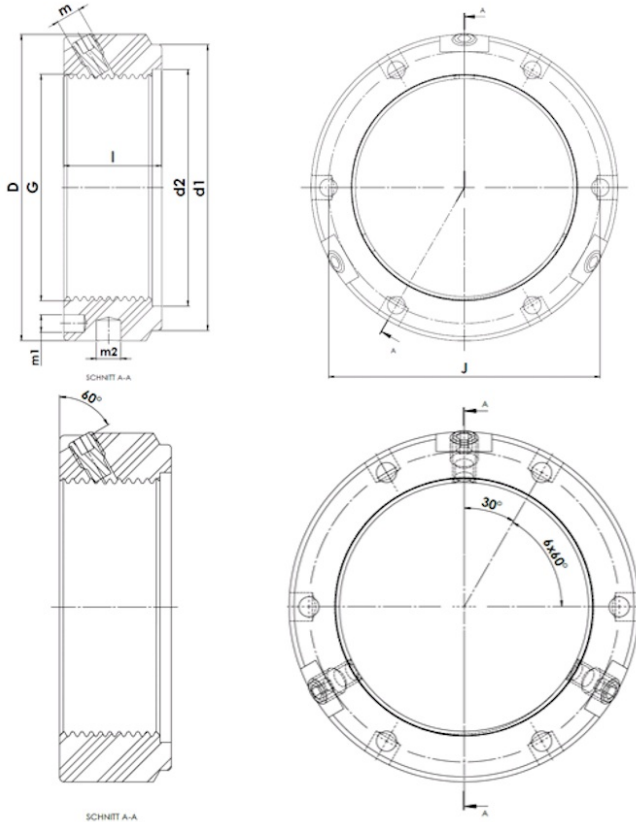

# KMTA 18

KMTA - Precision clamp nut, heavy duty, with three radial clamping pins



## Technical data

G	M90x2
l (mm)	32
D (mm)	120
d1 (mm)	110
d2 (mm)	93
J (mm)	108
m	M10
m1 (mm)	6
m2 (mm)	8
Weight (kg)	1.2