

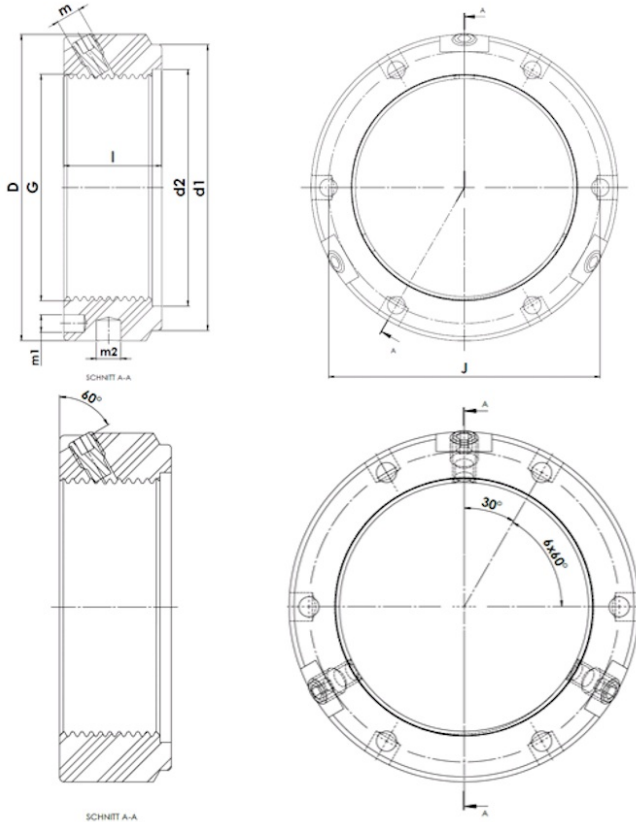

# KMTA 17

KMTA - Precision clamp nut, heavy duty, with three radial clamping pins



## Technical data

G	M85x2
l (mm)	32
D (mm)	115
d1 (mm)	102
d2 (mm)	88
J (mm)	100
m	M10
m1 (mm)	6
m2 (mm)	8
Weight (kg)	1.15

GTIN/EAN

