

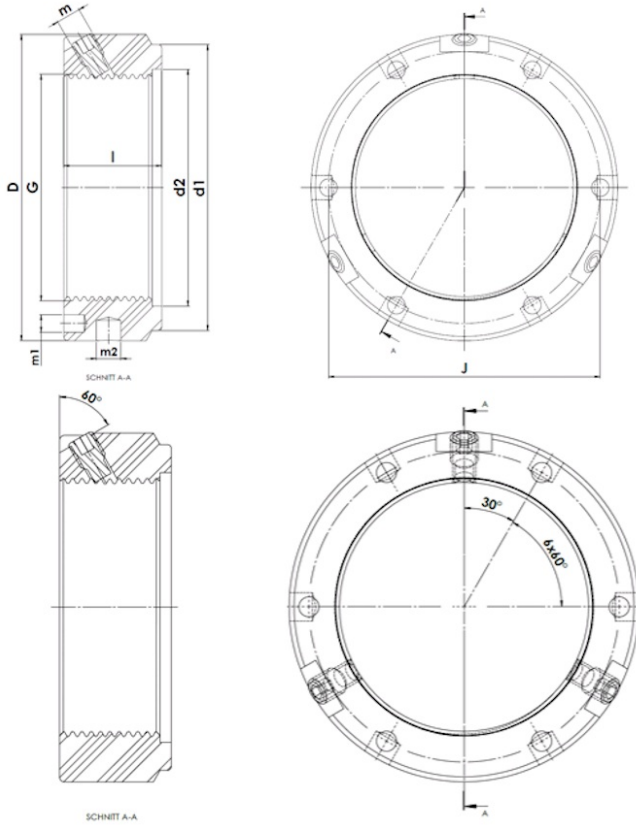

# KMTA 14

KMTA - Precision clamp nut, heavy duty, with three radial clamping pins



## Technical data

G	M70x1,5
l (mm)	26
D (mm)	95
d1 (mm)	86
d2 (mm)	72
J (mm)	85
m	M8x1
m1 (mm)	5
m2 (mm)	8
Weight (kg)	0.62

GTIN/EAN

