

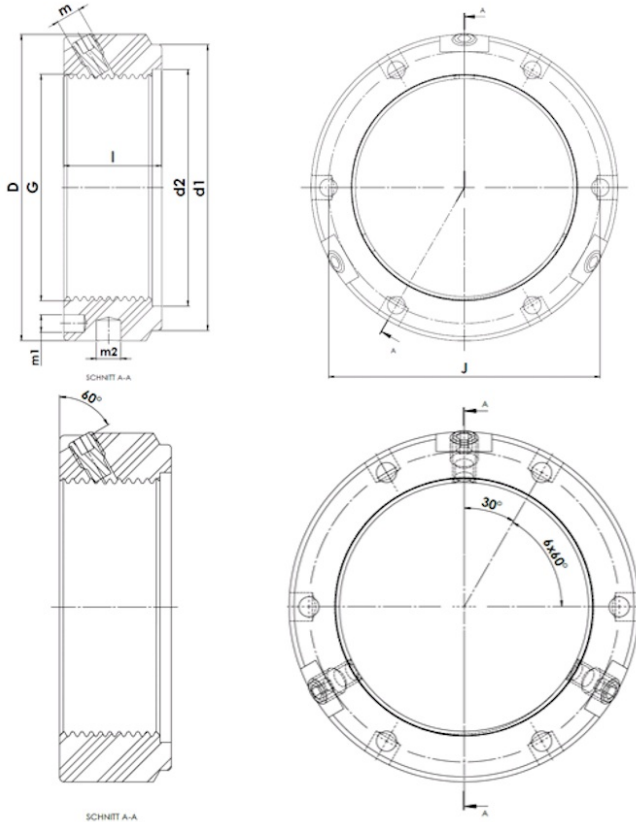

KMTA 7

KMTA - Precision clamp nut, heavy duty, with three radial clamping pins



Technical data

G	M35x1,5
l (mm)	20
D (mm)	53
d1 (mm)	47
d2 (mm)	38
J (mm)	45.5
m	M6
m1 (mm)	4
m2 (mm)	5
Weight (kg)	0.19