

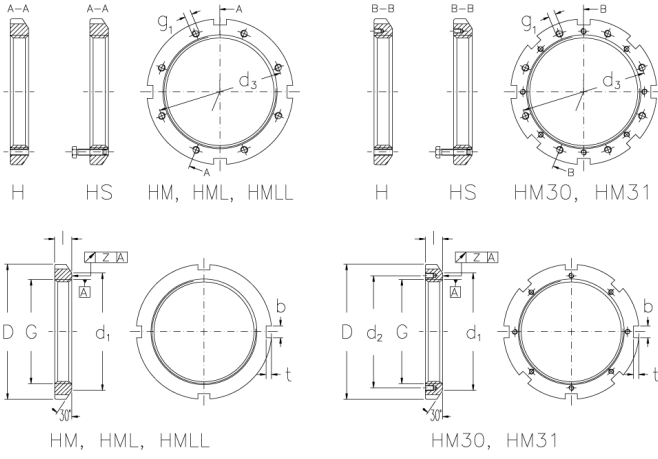

HM 110 THS

Muttern mit Trapezgewinde



Technische Daten

G	Tr 550x6
l (mm)	63
D (mm)	670
d1 (mm)	620
d2 (mm)	-
b (mm)	40
t (mm)	23
z (mm)	0,15
g1	M24
d3 (mm)	582
Gewicht (kg)	55,1