

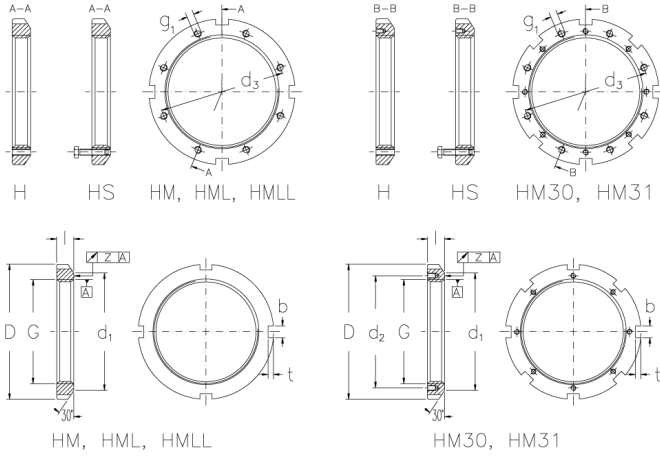

HM 88 T

Muttern mit Trapezgewinde



Technische Daten

G	Tr 440x5
l (mm)	51
D (mm)	540
d1 (mm)	500
d2 (mm)	-
b (mm)	36
t (mm)	20
z (mm)	0,15
g1	-
d3 (mm)	-
Gewicht (kg)	28,8

GTIN/EAN

