

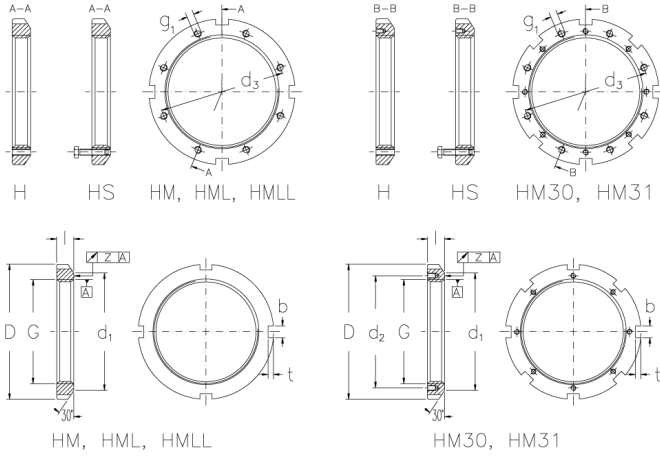

HML 86 T

Muttern mit Trapezgewinde



Technische Daten

G	Tr 430x5
l (mm)	41
D (mm)	500
d1 (mm)	472
d2 (mm)	-
b (mm)	32
t (mm)	14
z (mm)	0,15
g1	-
d3 (mm)	-
Gewicht (kg)	15,8

GTIN/EAN

