

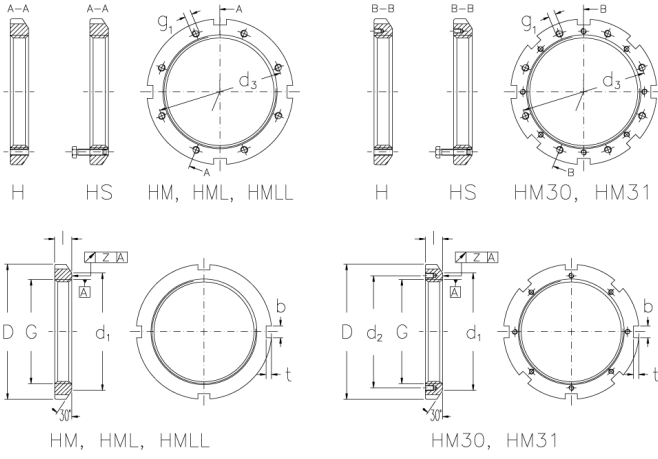

HM 84 T

Muttern mit Trapezgewinde



Technische Daten

G	Tr 420x5
l (mm)	49
D (mm)	520
d1 (mm)	480
d2 (mm)	-
b (mm)	32
t (mm)	18
z (mm)	0,15
g1	-
d3 (mm)	-
Gewicht (kg)	26,6

GTIN/EAN

