

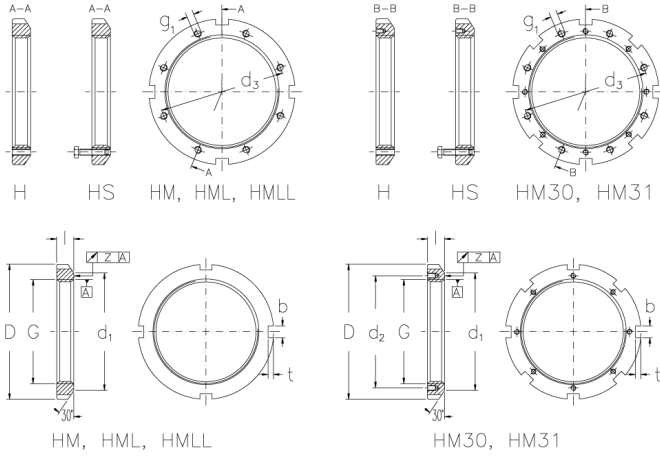

HM 80 T

Muttern mit Trapezgewinde



Technische Daten

G	Tr 400x5
l (mm)	46
D (mm)	500
d1 (mm)	460
d2 (mm)	-
b (mm)	32
t (mm)	18
z (mm)	0,12
g1	-
d3 (mm)	-
Gewicht (kg)	23,8

GTIN/EAN

