

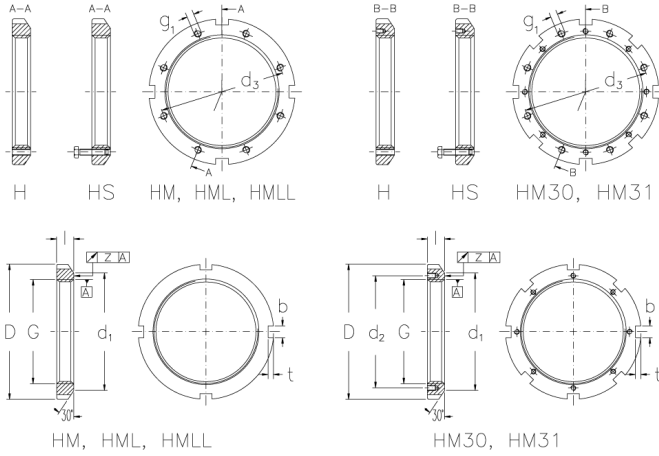

HM 3072 H

Muttern mit Trapezgewinde



Technische Daten

G	Tr 360x5
l (mm)	45
D (mm)	420
d1 (mm)	394
d2 (mm)	375
b (mm)	28
t (mm)	13
z (mm)	0,12
g1	M12
d3 (mm)	382
Gewicht (kg)	11,7

GTIN/EAN



Passende Teile zu diesem Produkt

MB 72 H
Montagebleche

MS 3072
Sicherungsbügel mit Schrauben