

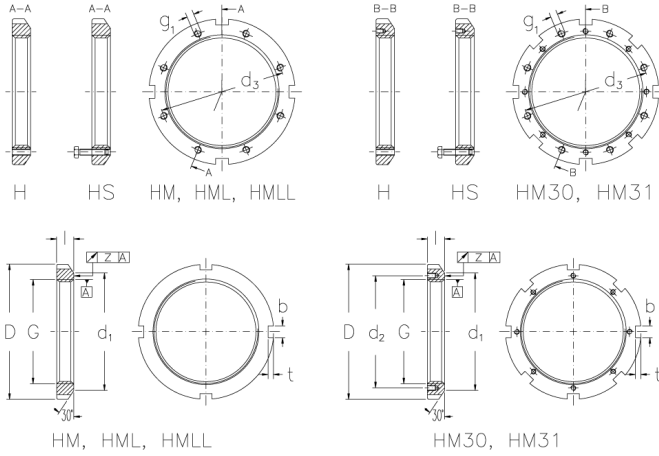

HM 3064 H

Muttern mit Trapezgewinde



Technische Daten

G	Tr 320x5
l (mm)	42
D (mm)	380
d1 (mm)	356
d2 (mm)	336
b (mm)	24
t (mm)	12
z (mm)	0,12
g1	M12
d3 (mm)	342
Gewicht (kg)	9,7

GTIN/EAN



Passende Teile zu diesem Produkt

MB 64 H
Montagebleche

MS 3064
Sicherungsbügel mit Schrauben