

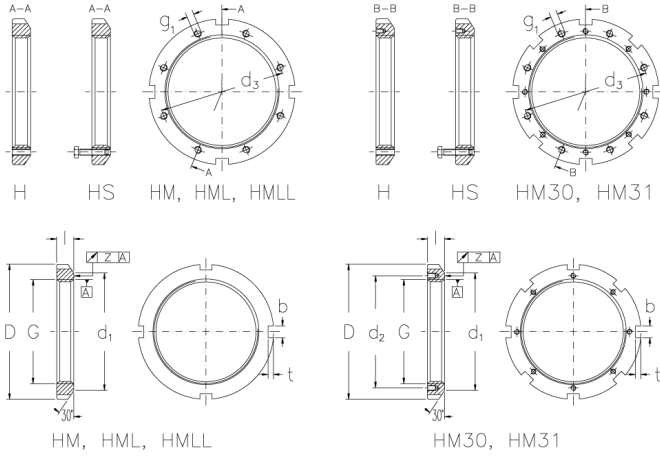

HM 58 T

Muttern mit Trapezgewinde



Technische Daten

G	Tr 290x4
l (mm)	36
D (mm)	365
d1 (mm)	335
d2 (mm)	-
b (mm)	24
t (mm)	12
z (mm)	0,12
g1	-
d3 (mm)	-
Gewicht (kg)	6,8

GTIN/EAN

