

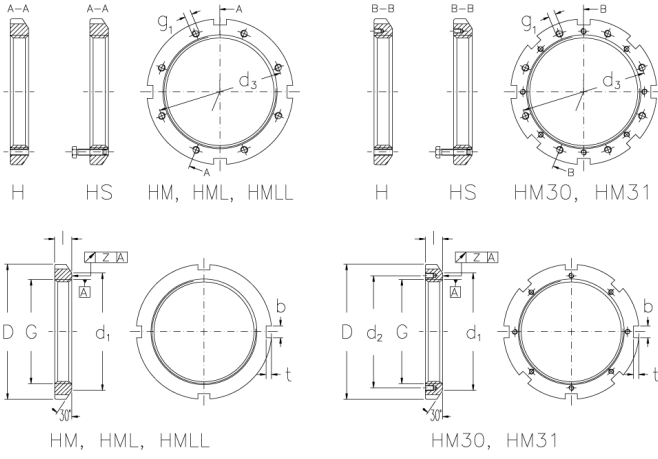

HML 52 T

Muttern mit Trapezgewinde



Technische Daten

G	Tr 260x4
l (mm)	30
D (mm)	310
d1 (mm)	290
d2 (mm)	-
b (mm)	20
t (mm)	10
z (mm)	0,12
g1	-
d3 (mm)	-
Gewicht (kg)	5,15

GTIN/EAN

