

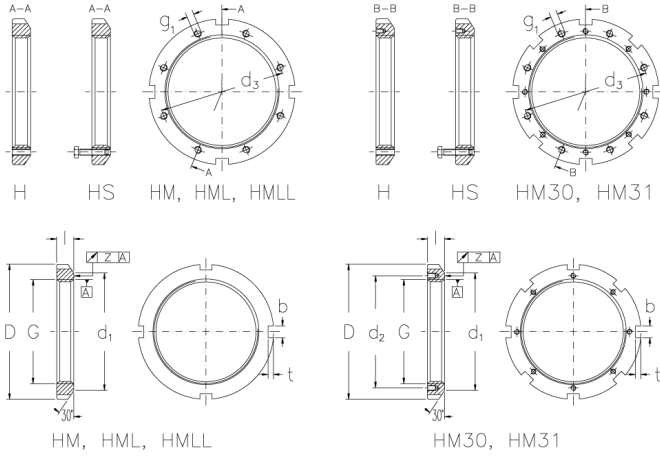

HM 50 THS

Muttern mit Trapezgewinde



Technische Daten

G	Tr 250x4
l (mm)	35
D (mm)	320
d1 (mm)	290
d2 (mm)	-
b (mm)	20
t (mm)	10
z (mm)	0,12
g1	M12
d3 (mm)	268
Gewicht (kg)	7,3