

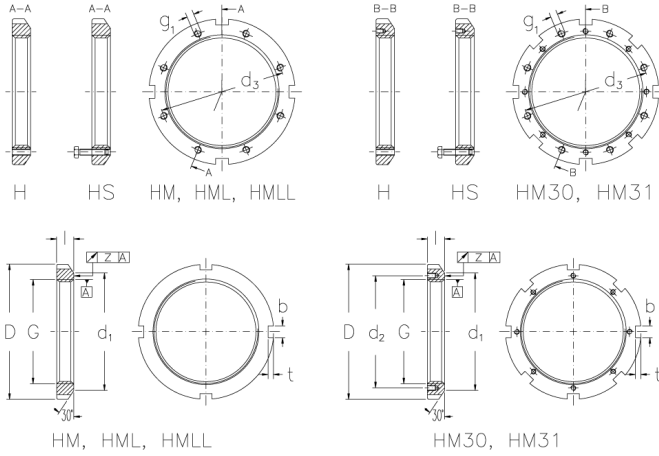

# HM 3044 H

Muttern mit Trapezgewinde



## Technische Daten

G	Tr 220x4
l (mm)	30
D (mm)	260
d1 (mm)	242
d2 (mm)	229
b (mm)	20
t (mm)	9
z (mm)	0,12
g1	M10
d3 (mm)	236
Gewicht (kg)	2,97

GTIN/EAN



## Passende Teile zu diesem Produkt

MB 44 H  
Montagebleche

MS 3044  
Sicherungsbügel mit Schrauben