

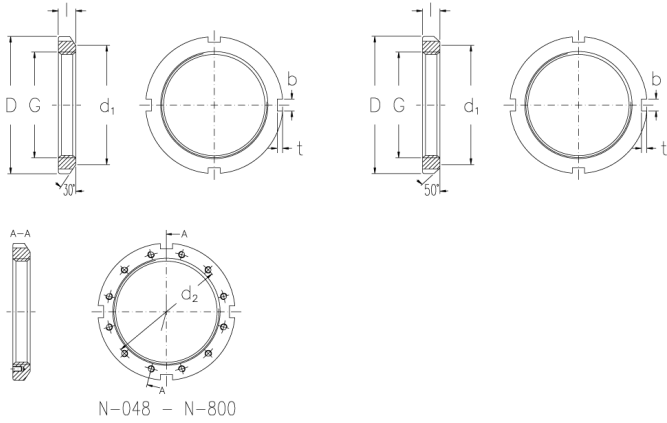

AN-19

Muttern mit Zoll-Abmessung



Technische Daten

G (Inch)	3,73
Gewindegänge pro Zoll	12
l (Inch)	0,729
D (Inch)	4,943
d1 (Inch)	4,563
b (Inch)	0,36
t (Inch)	0,166
d2 (Inch)	-
Gewicht (kg)	0,7

GTIN/EAN



Passende Teile zu diesem Produkt

W-19
Sicherungsbleche mit Zoll-Abmessung