

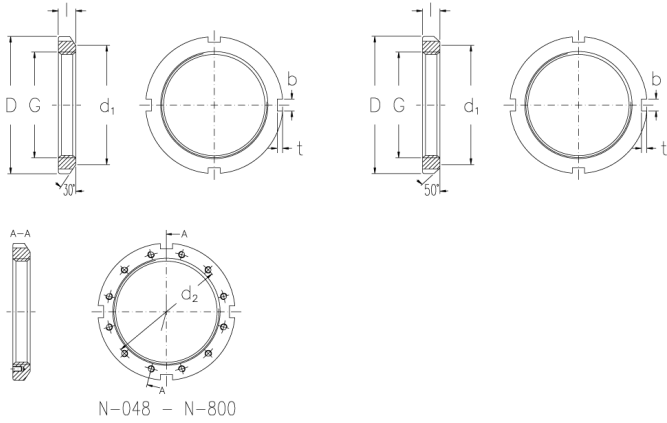

N-14

Muttern mit Zoll-Abmessung



Technische Daten

G (Inch)	2,751
Gewindegänge pro Zoll	18
l (Inch)	0,573
D (Inch)	3,63
d1 (Inch)	3,313
b (Inch)	0,24
t (Inch)	0,135
d2 (Inch)	-
Gewicht (kg)	0,27

GTIN/EAN



Passende Teile zu diesem Produkt

W-14
Sicherungsbleche mit Zoll-Abmessung