

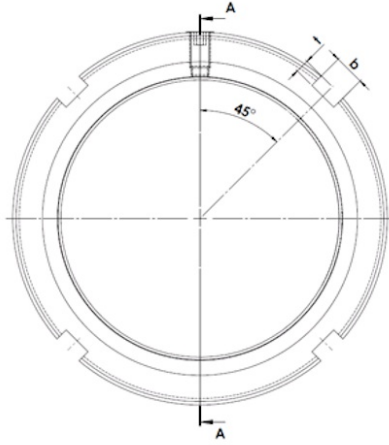

KMS1-14

Wellenmutter mit integriertem Sicherungselement



Technische Daten

G	M70x2
l (mm)	15
D (mm)	92
d1 (mm)	79
c1 (mm)	3
m	M6
b (mm)	8
t (mm)	3,5
Gewicht (kg)	0,3