

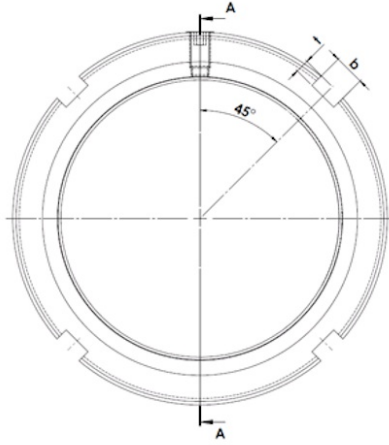

KMS1-06

Wellenmutter mit integriertem Sicherungselement



Technische Daten

G	M30x1,5
l (mm)	10,5
D (mm)	45
d1 (mm)	36
c1 (mm)	2
m	M5
b (mm)	5
t (mm)	2
Gewicht (kg)	0,07