

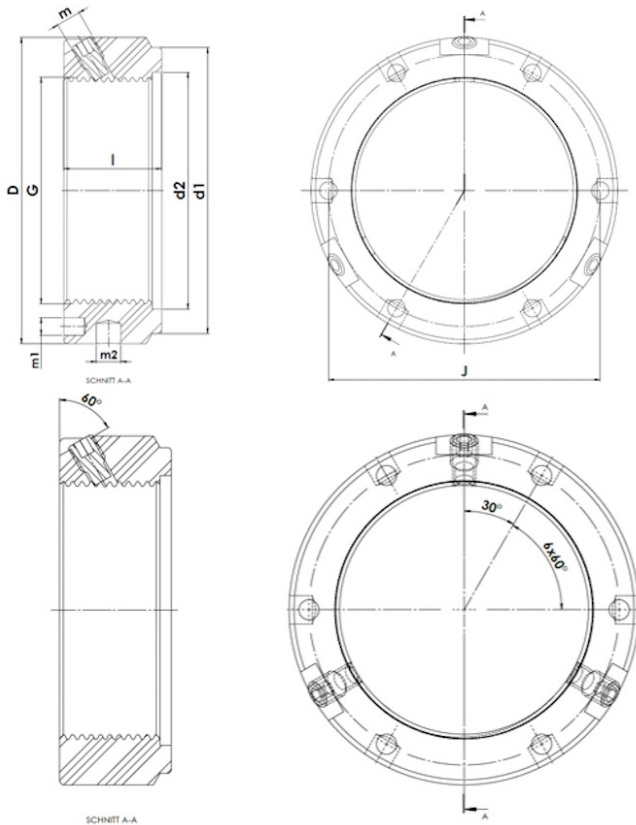

KMTA 24

KMTA - Präzisions-Wellenmutter, schwere Reihe mit drei radialen Sicherungsstiften



Technische Daten

G	M120x2
l (mm)	32
D (mm)	155
d1 (mm)	142
d2 (mm)	122
J (mm)	140
m	M10
m1 (mm)	6
m2 (mm)	8
Gewicht (kg)	1,85

GTIN/EAN

