

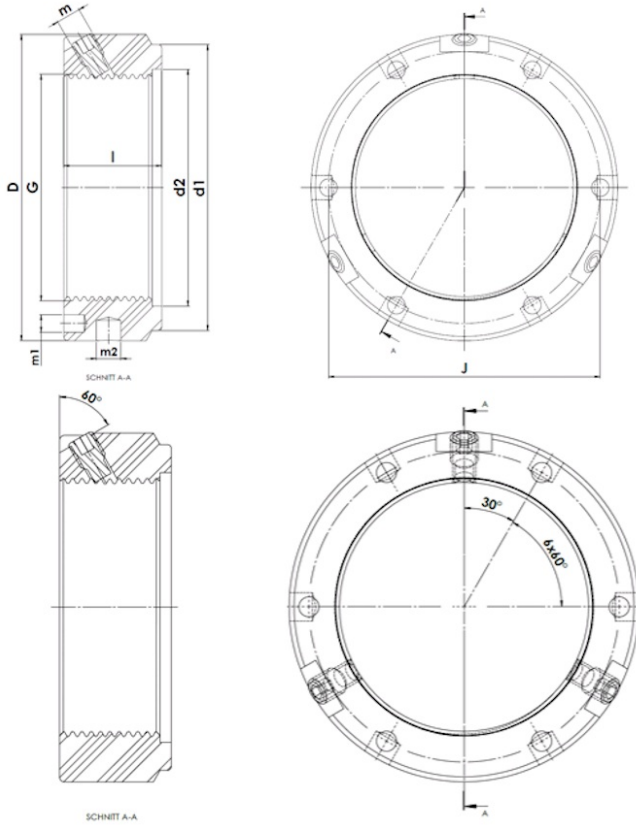

KMTA 22

KMTA - Präzisions-Wellenmutter, schwere Reihe mit drei radialen Sicherungstiften



Technische Daten

G	M110x2
l (mm)	32
D (mm)	140
d1 (mm)	132
d2 (mm)	112
J (mm)	128
m	M10
m1 (mm)	6
m2 (mm)	8
Gewicht (kg)	1,45

GTIN/EAN

