

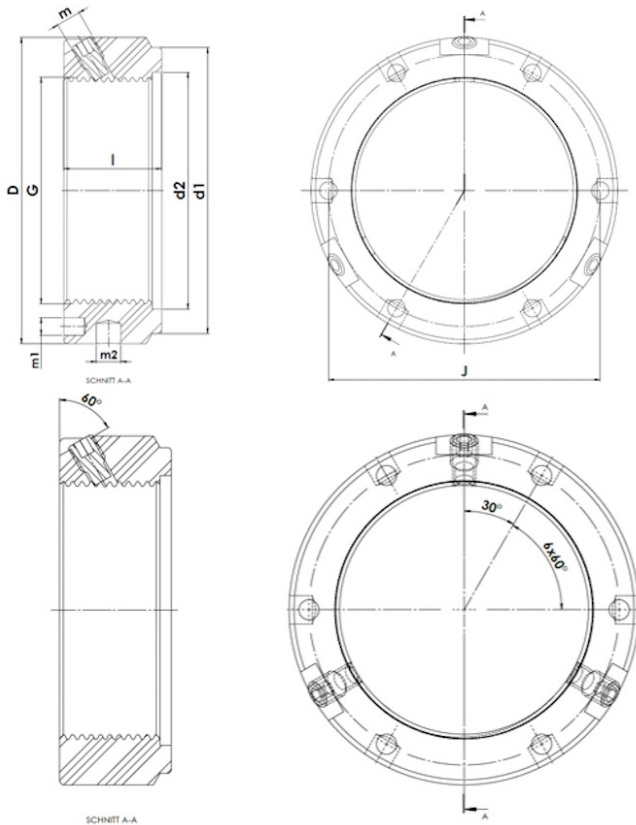

# KMTA 19

KMTA - Präzisions-Wellenmutter, schwere Reihe mit drei radialen Sicherungstiften



## Technische Daten

G	M95x2
l (mm)	32
D (mm)	125
d1 (mm)	114
d2 (mm)	98
J (mm)	113
m	M10
m1 (mm)	6
m2 (mm)	8
Gewicht (kg)	1,25