

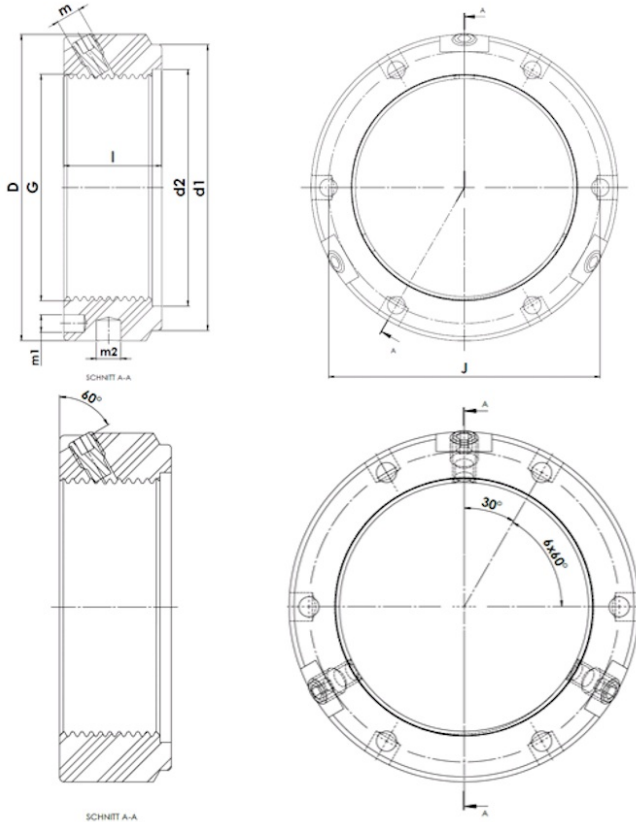

KMTA 8

KMTA - Präzisions-Wellenmutter, schwere Reihe mit drei radialen Sicherungstiften



Technische Daten

G	M40x1,5
l (mm)	22
D (mm)	58
d1 (mm)	52
d2 (mm)	42
J (mm)	50,5
m	M6
m1 (mm)	4
m2 (mm)	5
Gewicht (kg)	0,23