

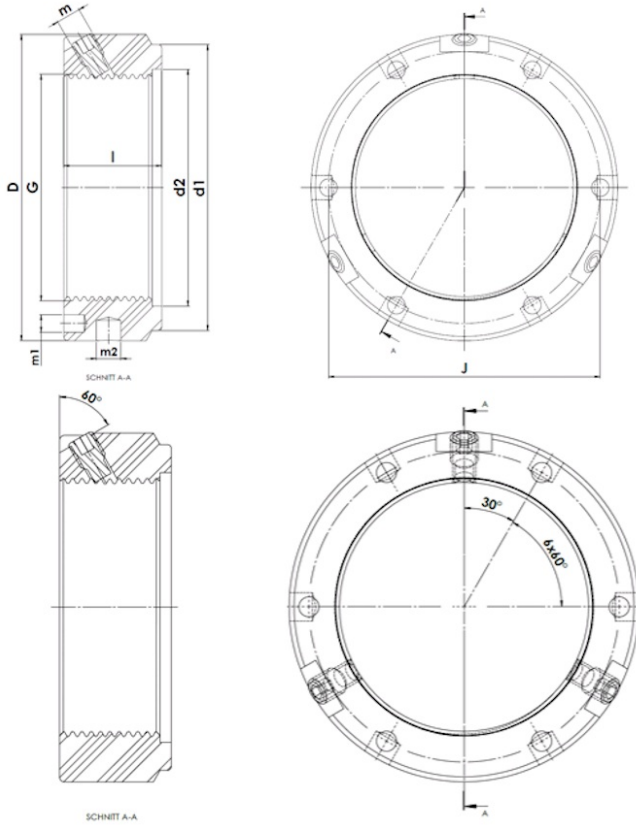

KMTA 6

KMTA - Präzisions-Wellenmutter, schwere Reihe mit drei radialen Sicherungstiften



Technische Daten

G	M30x1,5
l (mm)	20
D (mm)	48
d1 (mm)	40
d2 (mm)	32
J (mm)	40,5
m	M6
m1 (mm)	4
m2 (mm)	5
Gewicht (kg)	0,16

GTIN/EAN

