

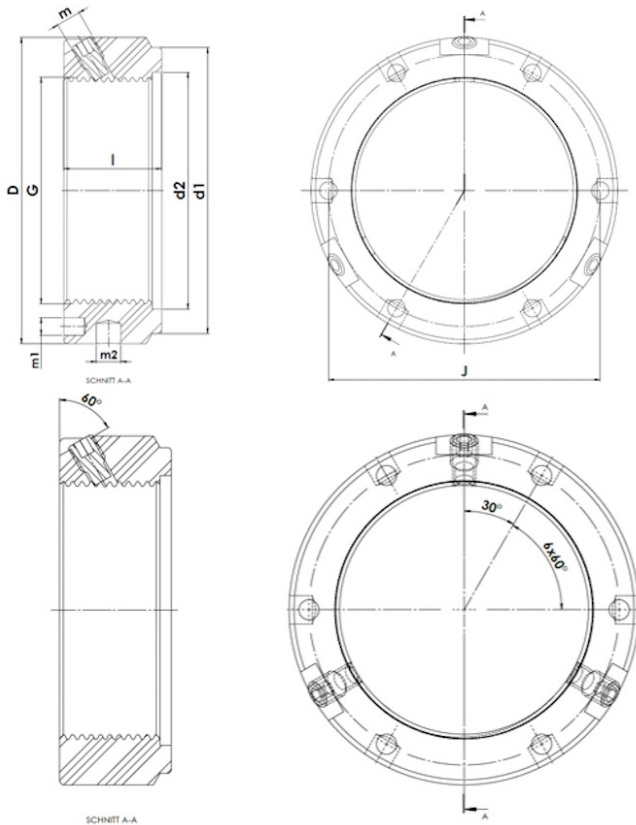

# KMTA 5

KMTA - Präzisions-Wellenmutter, schwere Reihe mit drei radialen Sicherungstiften



## Technische Daten

G	M25x1,5
l (mm)	20
D (mm)	42
d1 (mm)	35
d2 (mm)	26
J (mm)	32,5
m	M6
m1 (mm)	4
m2 (mm)	4
Gewicht (kg)	0,13

GTIN/EAN

